

I dati riportati sul presente documento sono da ritenersi non vincolanti. oem ALI S.p.a. si riserva di apportare modifiche tecniche in qualsiasi momento.
The specifications shown in this document are to be considered not binding. oem ALI S.p.a. reserves the right to make technical changes at any moment.



oem

The Original Pizza System

Teléfono: +34 942 68 35 22

ali
GROUP



The Original Pizza System



OPTYMO

FORNO ELETTRICO | *ELECTRIC OVEN*



IL FORNO ELETTRICO MODULARE
CHE PORTA LA ZONA COTTURA
AL CENTRO DEL DESIGN.

*THE MODULAR ELECTRIC OVEN
THAT LEADS YOUR COOKING AREA
TO THE HEART OF DESIGN.*

Optymo mette in mostra le tue abilità in cucina.

Optymo shows your cooking skills.

Optymo è la linea di forni elettrici modulari progettata per adattarsi alle esigenze dello spazio operativo della cucina e alla produttività del tuo locale. Una nuova linea di forni dal **design esclusivo** che interpreta i trend del momento con **eleganza** e **raffinatezza**. Il rivestimento in gres porcellanato a spessore ridotto di 6 mm, unico nel suo genere, garantisce una resa estetica di lunga durata che si inserisce perfettamente nelle **cucine a vista** più moderne.

Il nuovo rivestimento, **antiraffio** e **resistente** alle alte temperature, è anche semplice da pulire, per una perfetta **igiene** della zona cottura. I forni sono disponibili in diversi formati, modulabili da 1 a 3 camere, per consentirti di avere sempre la **soluzione su misura**, a seconda delle tipologie di pizza da infornare (tonde da \varnothing 30, 35 o 45cm o teglie da 60x40cm) e della produttività oraria che desideri.

*Optymo is a line of modular electric ovens designed to fit your cooking area's specific characteristics and productivity. A new range of ovens with an **exclusive design**, an **elegant** and **refined** interpretation of the contemporary trends. The unique 6 mm thick porcelain stoneware coating ensures long lasting aesthetic features that tailor perfectly with modern **open-style kitchens**.*

*The new coating, **scratchproof** and **resistant** to high temperatures, is very easy to clean, to guarantee a perfect **hygiene** in the cooking area. Ovens are available in different sizes and are modular, from 1 to 3 chambers, to offer **customized solutions** according to the type of pizza (round with a 30, 35 or 45 cm \varnothing or in 60x40 cm baking trays) and the desired hourly productivity.*

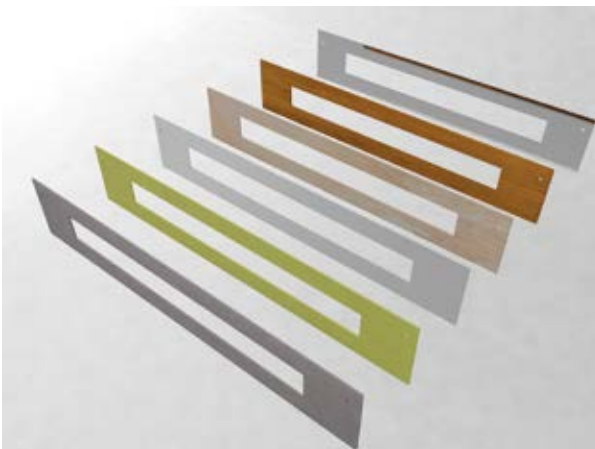

**LASCIA CHE
IL FORNO
LAVORI PER TE.**

**LET THE OVEN
DO ALL
THE WORK.**

Il forno è completamente automatizzato per semplificare la gestione e le operazioni di cottura. Il computer di bordo, facile e intuitivo, ti consente di variare i parametri dei 3 programmi preimpostati per ottimizzare la cottura in funzione dalle tue ricette. Puoi anche impostare l'avvio automatico 2 volte al giorno e trovare il forno già caldo, pronto per la prima infornata.

The oven is completely computerized to simplify the management of the pre-set cooking operations.

The user-friendly built-in computer, allows you to change the parameters of the 3 pre-set programs, to optimize baking according to your recipes. You can also program the automatic starting 2 times a day to find your oven hot and ready for baking.

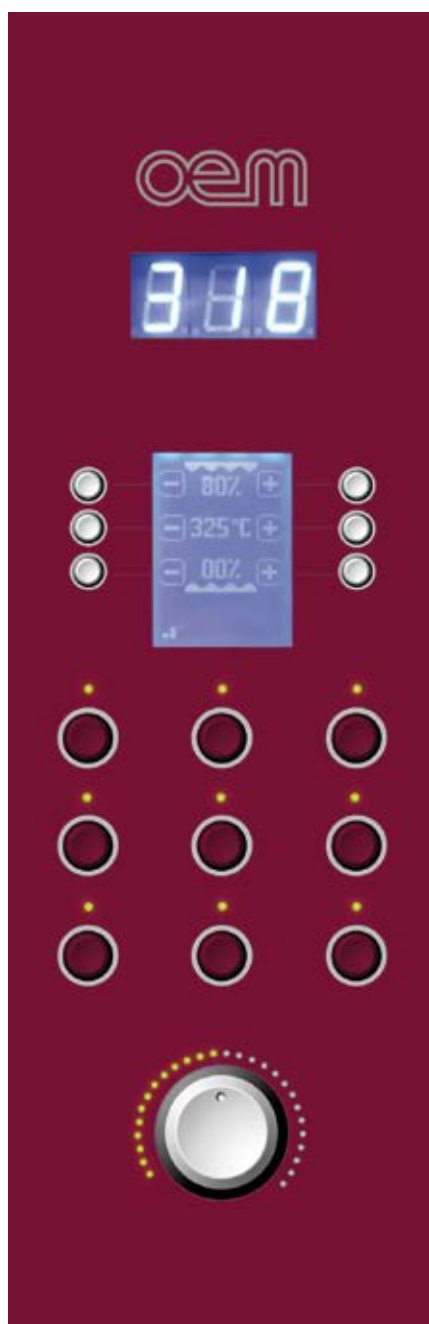

PANNELLO COMANDI CONTROL PANEL

Ampio display, accesso a tutte le funzioni del menù.

Large display to easily control all menu functions.

BASTA UN'OCCHIATA IT ONLY TAKES A GLANCE

Display a LED per monitoraggio temperatura e funzioni impostate.

LED display to control temperatures and active functions.

GUADAGNI TEMPO YOU SAVE TIME

Autopulizia a 400°C e spegnimento automatico.

400°C auto-cleaning and auto-shutdown functions.

QUANDO E COME VUOI WHEN AND HOW YOU WANT

Autoaccensione 2 volte al giorno, 7 giorni su 7.

Auto-starting functions 2 times a day, every day.

**PIANO IN PIETRA REFRAATTARIA AD ALTO
SPESSORE PER CUOCERE A MATTONE.**

***THICK REFRACTORY STONE
SURFACE FOR BRICK BAKING.***

MANUTENZIONE SEMPLIFICATA, SUL FRONTALE / *SIMPLIFIED MAINTENANCE, ON THE FRONT PART*



Tutta la manutenzione avviene dal frontale, per interventi più semplici e veloci che non incidono sulla tua produttività.

All the simple and fast interventions of maintenance that don't engrave on the productivity can be made from the front part.

ACCESSORI / *ACCESSORIES*

Carrello di supporto con ruote e alzate telescopiche integrate, regolabili in altezza (max. 27,5 cm.)

Cella neutra con ruote e alzate telescopiche integrate, regolabili in altezza (max. 27,5 cm.)

Support carriage with wheels and integrated telescopic risers adjustable in height (max. 27,5 cm).

Neutral beehive with wheels and integrated telescopic risers adjustable in height (max. 27,5 cm).

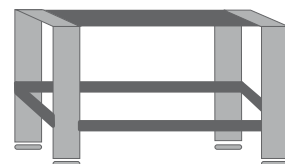
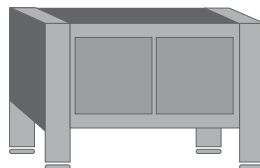

**COTTURE PERFETTE
GRAZIE ALLE
TECNOLOGIE
PIU' INNOVATIVE.**

***THE MOST
INNOVATIVE
TECNOLOGIES
FOR PERFECT BAKING.***

Grazie a 6 zone di cottura controllabili tramite microprocessore, il forno differenzia 3 distinte potenze per il cielo e 3 per la platea (parte anteriore, mediana e posteriore), la cottura risulta croccante e uniforme, anche senza ruotare la pizza. Lo strato isolante ottenuto con lana di roccia trattata, ricoperta da fogli di alluminio, evita la dispersione del calore lasciando il forno freddo esternamente (max. 50°C).

Thanks to 6 cooking zones, controllable by microprocessor - the oven has 3 distinctive heat levels for the top and 3 for the bottom (front, middle and rear part) - the baking results crispy and uniform, even without rotating the pizza. The insulation layer obtained with treated wool stone, covered with aluminum layers, makes it possible to keep the heat into the cooking chamber, (maximum external surfaces' temperature is 50°C).



SUPERFICIE DI PIETRA REFRATTARIA / *THICK REFRACTORY STONE SURFACE*

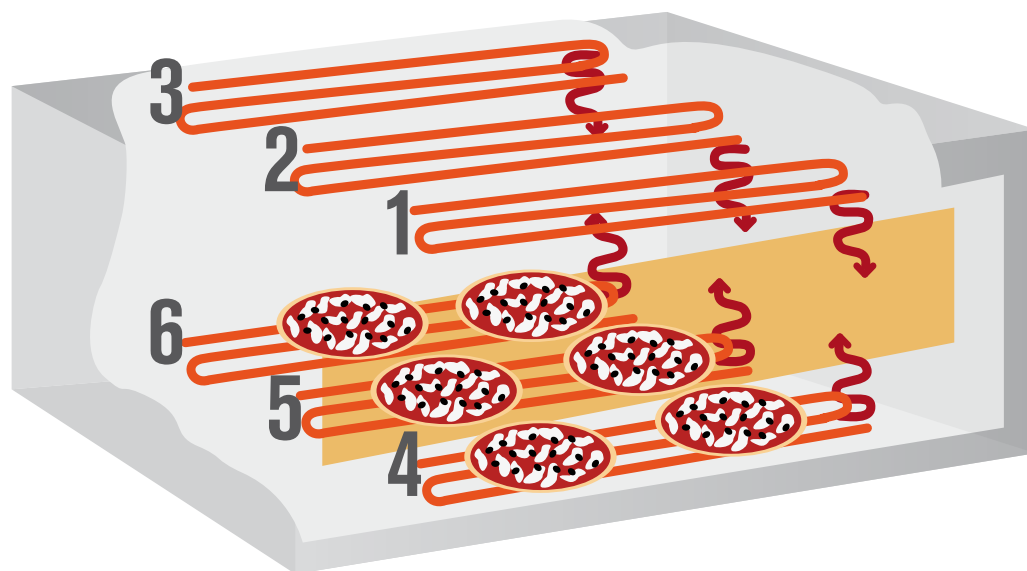

6 ZONE DI COTTURA:
3 IN CIELO
3 IN PLATEA

6 BAKING ZONES:
3 ON TOP
3 ON THE BOTTOM

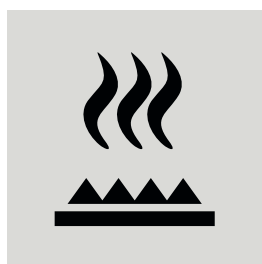

COTTURE UNIFORMI *UNIFORM BAKING*

Grazie al sistema bilanciato a compensazione di calore non devi più girare la pizza durante la cottura.

Thanks to the centered compensation heat system you don't need to rotate the pizza during the baking.

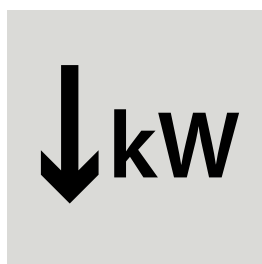

RIDUCE I CONSUMI *IT REDUCES CONSUMPTIONS*

Il microprocessore ottimizza in funzionamento delle resistenze con un uso razionale della potenza.

The microprocessor optimizes the operation of the heating coils with a balanced use of power.



INFORNATA PIÙ VELOCE *BAKING IS FASTER*

Grazie a un veloce recupero della temperatura, il passaggio da cottura in teglia a cottura su pietra e vice versa è più rapido.

Thanks to the fast recovery of the temperature, the transition from baking in trays or directly on the refractory surface, is faster.

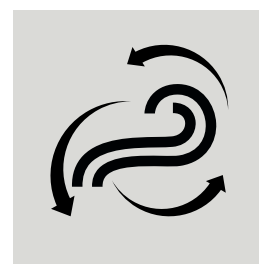

ASPIRA SENZA LA CAPPA *DRAWNS WITHOUT THE HOOD*

Il modulo di aspirazione integrato e dedicato incanala ed espelle in modo ottimale i fumi di cottura.

Each chamber is made of an integrated aspiration system that canalizes and dismisses all the baking fumes.

**IL TUO LOCALE NON È COME GLI ALTRI.
SCEGLI UN FORNO A MISURA DEL TUO STILE.**

***YOUR PLACE ISN'T LIKE THE OTHERS.
CHOOSE THE PERFECT OVEN FOR YOUR STYLE.***





**FINITURE DI DESIGN IN GRES
PORCELLANATO PER CUCINE A VISTA.**

***DESIGN FINISH IN PORCELAIN STONEWARE
FOR OPEN STYLE KITCHENS.***



FINITURE / FINISH



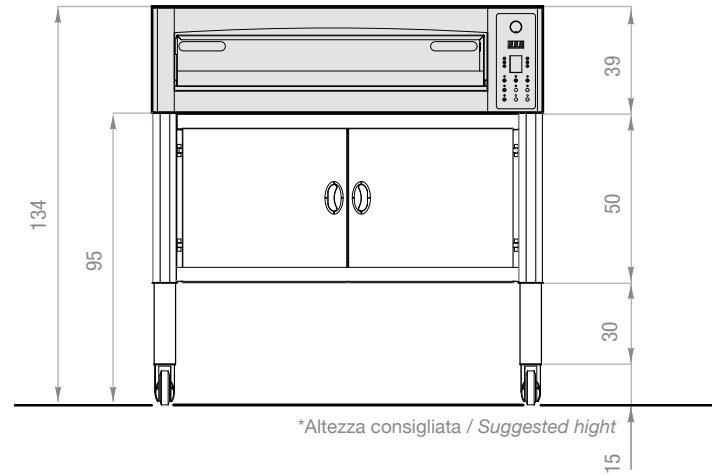

MOD 435 1

108 X 108 X 39 cm
 kW max. 5,4
 Diametro / Diameter Ø 35
 Nr. pizze 4
 Produttività 40/h
 Productivity 40/h

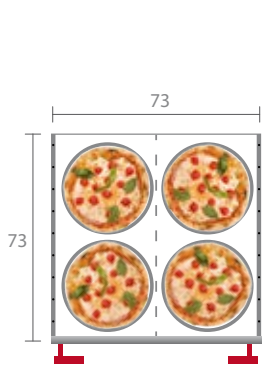

MOD 635S 1

108 X 146 X 39 cm
 kW max. 8,6
 Diametro / Diameter Ø 35
 Nr. pizze 6
 Produttività 60/h
 Productivity 60/h

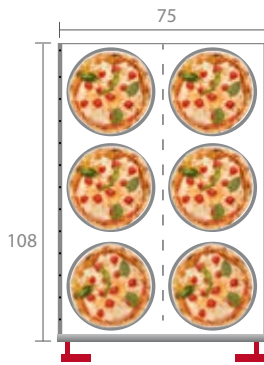

MOD 635L 1

146 X 108 X 39 cm
 kW max. 9,6
 Diametro / Diameter Ø 35
 Nr. pizze 6
 Produttività 60/h
 Productivity 60/h

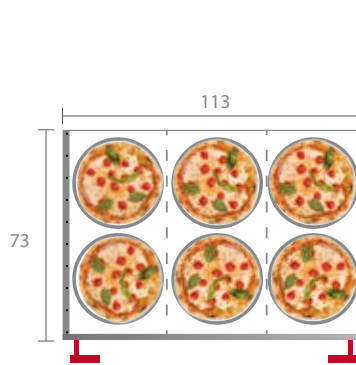

MOD 935 1

146 X 146 X 39 cm
 kW max. 12,6
 Diametro / Diameter Ø 35
 Nr. pizze 9
 Produttività 60/h
 Productivity 60/h

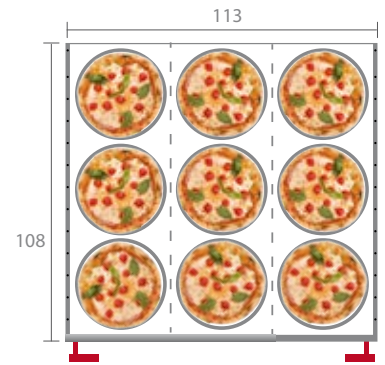

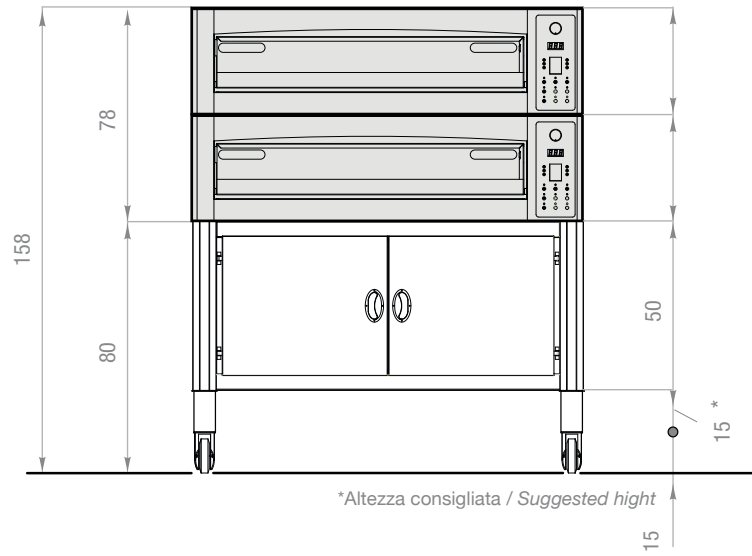

MOD 435 2

108 X 108 X 78 cm
 kW max. 10,8
 Diametro / Diameter Ø 35
 Nr. pizze 8
 Produttività 80/h
 Productivity 80/h

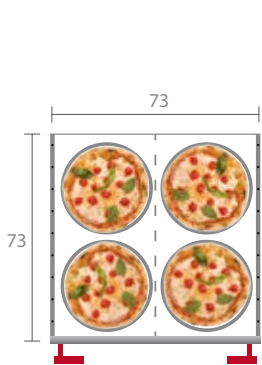

MOD 635S 2

108 X 146 X 78 cm
 kW max. 17,2
 Diametro / Diameter Ø 35
 Nr. pizze 12
 Produttività 120/h
 Productivity 120/h

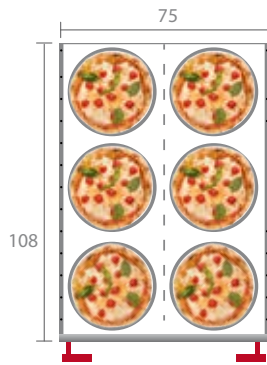

MOD 635L 2

146 X 108 X 78 cm
 kW max. 19,2
 Diametro / Diameter Ø 35
 Nr. pizze 12
 Produttività 120/h
 Productivity 120/h

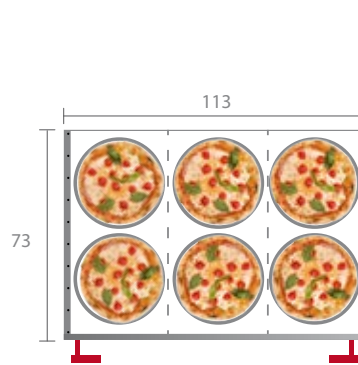

MOD 935 2

146 X 146 X 78 cm
 kW max. 25,8
 Diametro / Diameter Ø 35
 Nr. pizze 18
 Produttività 180/h
 Productivity 180/h

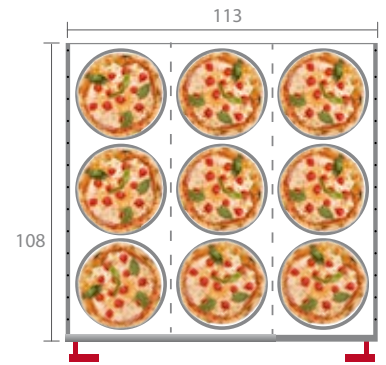

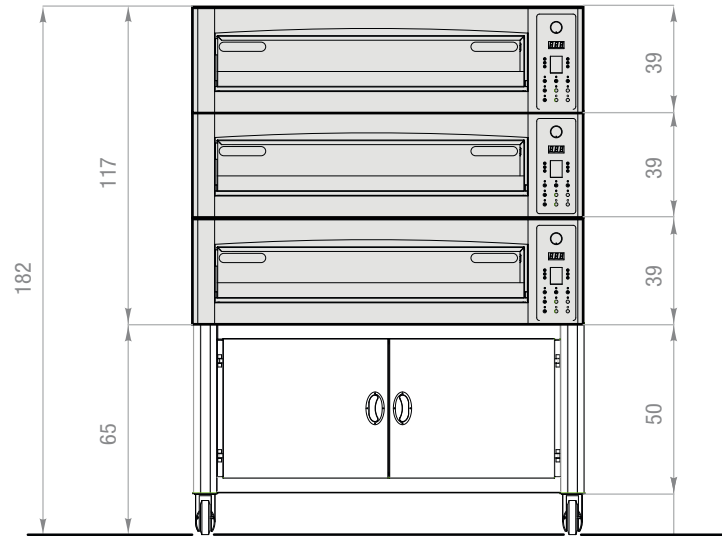

MOD 435 3

MOD 635S 3

MOD 635L 3

MOD 935 3

108 X 108 X 117 cm

kW max. 16,2

Diametro / Diameter Ø 35

Nr. pizze 12

Produttività 120/h

Productivity 120/h

108 X 146 X 117 cm

kW max. 25,8

Diametro / Diameter Ø 35

Nr. pizze 18

Produttività 180/h

Productivity 180/h

146 X 108 X 117 cm

kW max. 28,8

Diametro / Diameter Ø 35

Nr. pizze 18

Produttività 180/h

Productivity 180/h

146 X 108 X 117 cm

kW max. 37,8

Diametro / Diameter Ø 35

Nr. pizze 27

Produttività 270/h

Productivity 270/h

